

## Air diffusion systems

### Swirl diffuser Type DA

#### General

The DA range of low cost fixed air pattern steel diffusers is designed for supplying air in conditioning and ventilation systems for both comfort and industrial applications.

Their special features include:

- Ability to handle high cooling loads due to efficient induction of room to supply air.
- Draught free room conditions with low mounting heights.
- Efficient temperature equalisation in the occupied zone.
- They do not rely on the COANDA effect for the air pattern therefore they can be installed without a ceiling or above an open cell ceiling.
- The front face of the diffuser does not have unsightly cones projecting below the surface.
- The upper surface minimum in area and mainly vertical thereby reducing traps for dust and other contaminants.
- The overall dimensions are at a minimum.

The requirements of DIN 1946 Pt 2 are met at maximum temperature differences of 10K cooling 4K heating.

#### Function

Low air velocity and draught free conditions in the occupied zone are achieved by virtue of the unique air deflection blade design which create a high rate of secondary air induction while at the same time maintaining a symmetrical horizontal rotating air pattern.

#### Sizes

The available sizes are show in the table opposite.

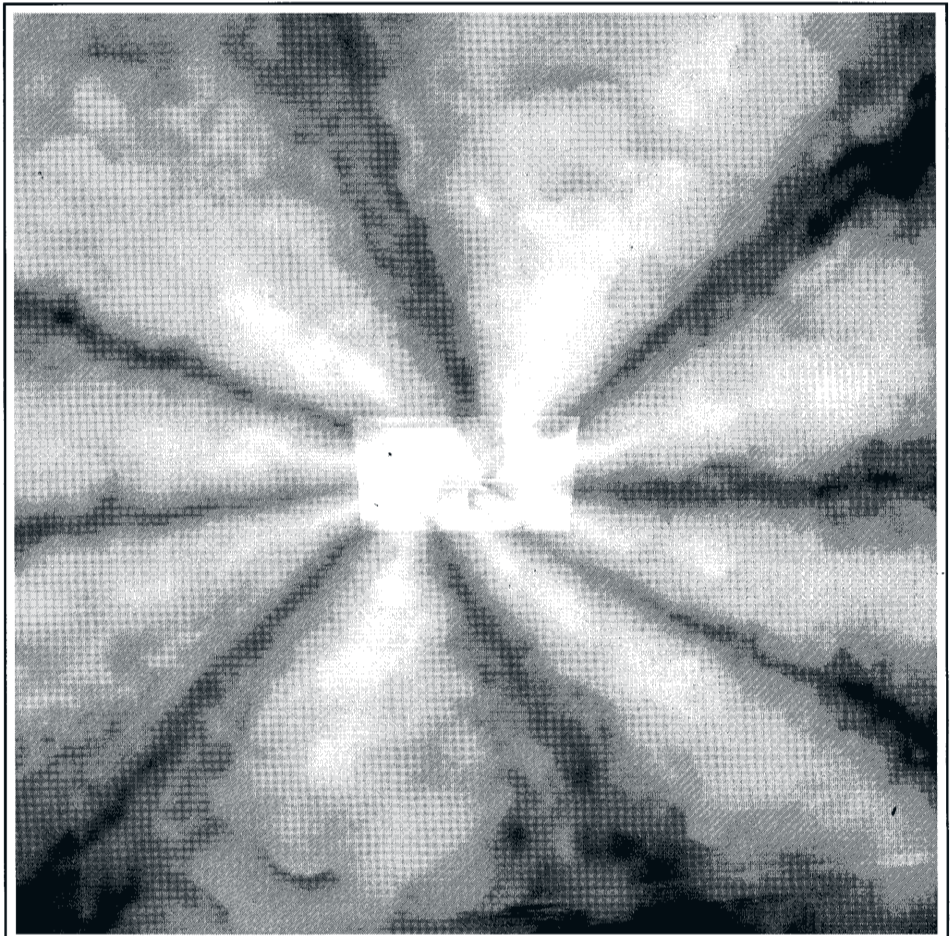

#### Size available

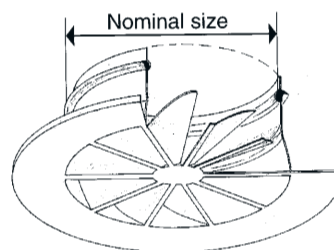

(nominal diameters)

|     |     |
|-----|-----|
| 125 | 315 |
| 160 | 355 |
| 200 | 400 |
| 250 | 450 |

# Swirl diffuser Type DA

## Applications

- Business areas
- Department stores
- Offices
- Factories

## Content

|   | page   |
|---|--------|
| General, function, sizes .....  | 1      |
| Applications .....  | 2      |
| Construction, dimensions, flange forms .....                                | 3      |
| Surface finishes, flange forms .....  | 4      |
| Connection, plenum and supplementary components, installation methods ..... | 5 – 7  |
| Design and selection data .....   | 8 – 10 |
| Pressure loss, noise levels .....   | 11     |
| Selection example .....   | 12     |
| Tender text .....   | 13     |



Foyer: Multiple cinema complex, Gelsenkirchen



Restaurant/bar: Hansa Hotel, Diedenbergen



Conference room: Hansa Hotel, Diedenbergen



Factory area: Quante, Hattingen

The company reserves the right of design change without notice.

# Swirl diffuser Type DA

# Construction, dimensions and flange forms

## Construction and dimensions

The DA diffuser is constructed of the following elements: ① Face plate with between 8 and 24 swirl blades depending on the size of the diffuser and ② specially formed connection spigot complete with sealing gasket.

Both elements are constructed from steel.

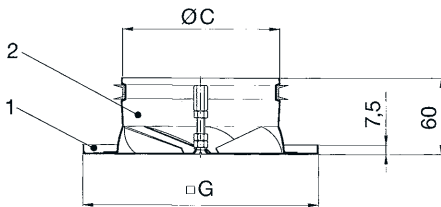

| Nominal diffuser size | Dimensions in mm |     | No. of swirl blades |
|-----------------------|------------------|-----|---------------------|
|                       | CØ               | G   |                     |
| 125                   | 123              | 185 | 8                   |
| 160                   | 158              | 240 | 10                  |
| 200                   | 198              | 310 | 13                  |
| 250                   | 248              | 380 | 16                  |
| 315                   | 313              | 490 | 19                  |
| 355                   | 353              | 550 | 20                  |
| 400                   | 398              | 590 | 22                  |
| 450                   | 448              | 620 | 24                  |

The DA diffuser is supplied with an M6 screw to facilitate easy and safe fixing and also its removal from a connecting cone, plenum box etc.

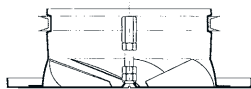

## Flange variations for DA diffusers

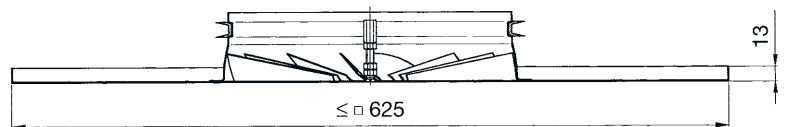
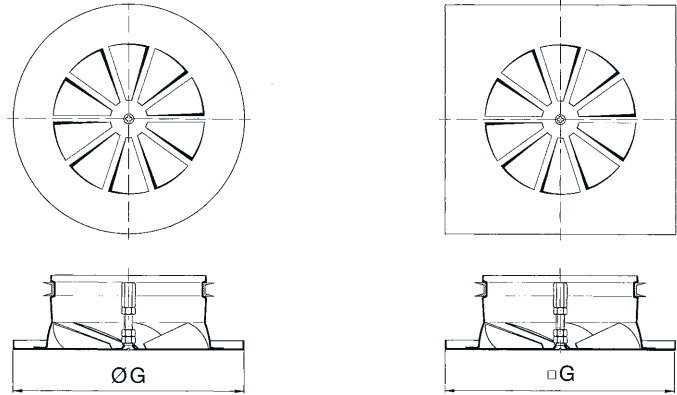

Flanges are available with dimension up to 625<sup>□</sup>

## Swirl diffuser Type DA

Finishes an flange forms

### Finishes available

The range of DA diffusers is available in the following materials and finishes:

**Material sheet steel:**

Surface finish: Powder coated RAL 9010 (Standard)  
extra price for any other RAL colour

**Material stainless steel:**

Surface finish on request

### Flange forms

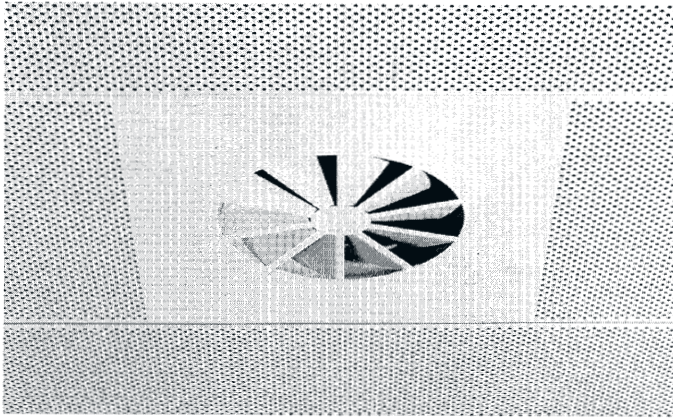

Diffuser formed as part of perforated panel

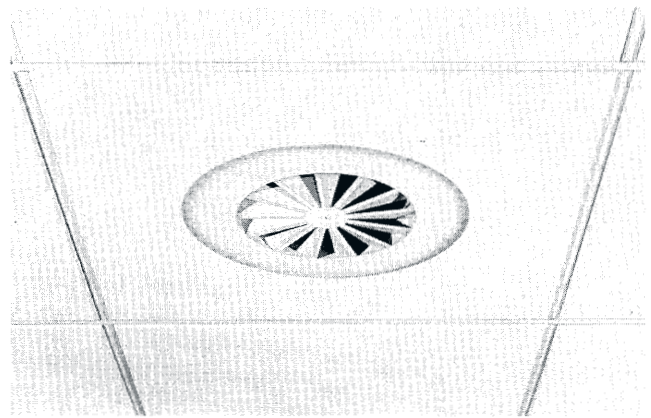

Standard circular flange

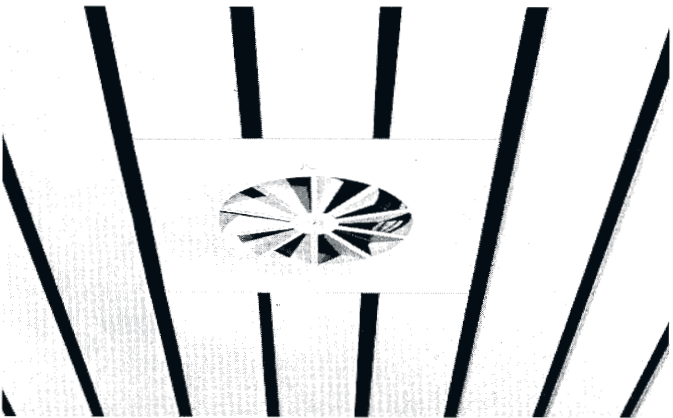

Rectangular flange for slatted ceilings

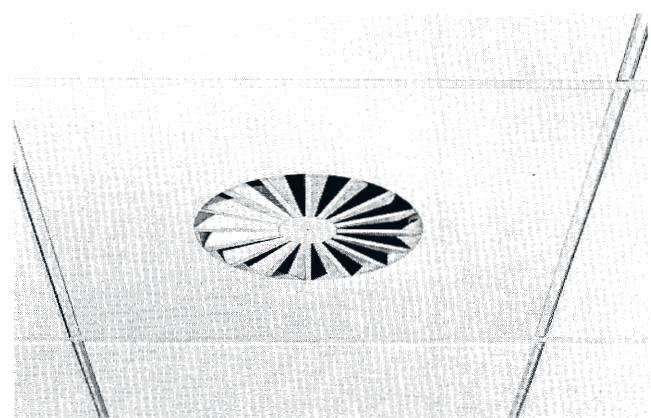

Rectangular flange for lay-in ceilings

## Swirl diffuser Type DA

## Connection components

### Connection methods and supplementary components

Standard DA diffusers can be supplied with various connection cones.

The main purpose of these cones is to achieve:

- The required air direction to the diffuser
- Equalisation of the air flow
- The required pressure loss.
- A reduction of the duct size relative to the nominal size of the diffuser

### Standard connection cones (Type U)

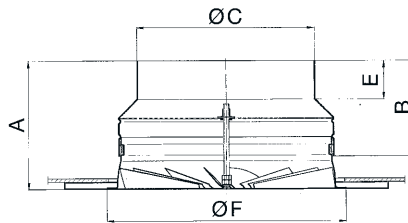
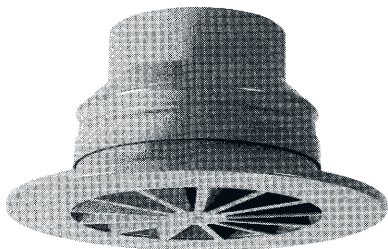

swirl diffuser by means of center screw to be fixed to the connection cone (elements delivered separately)

| Nominal diffuser size | Dimension in mm |     |     |    |     |
|-----------------------|-----------------|-----|-----|----|-----|
|                       | A               | B   | C   | E  | F   |
| DN 125                | 137             | 102 | 98  | 43 | 160 |
| DN 160                | 137             | 102 | 123 | 41 | 195 |
| DN 200                | 147             | 112 | 158 | 45 | 235 |
| DN 250                | 167             | 132 | 198 | 45 | 285 |
| DN 315                | 190             | 155 | 248 | 50 | 350 |
| DN 355                | 223             | 188 | 248 | 50 | 390 |
| DN 400                | 235             | 200 | 313 | 40 | 435 |
| DN 450                | 255             | 220 | 353 | 40 | 485 |

### Special connection cones

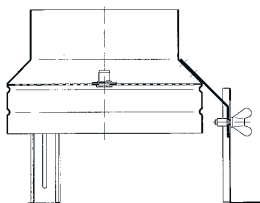

**Connection cone with fixing lugs (Type UF)**  
Connection cone for later installation in suspended ceiling

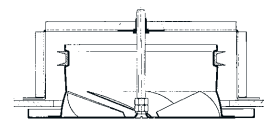

**Traverse for installation of the diffuser in the ceiling (Type T)**

## Swirl diffuser Type DA

## Plenum boxes

### Standard plenum box Type AK

#### Plenum box (Type AK)

Rectangular plenum box (fixing of diffuser by means of centre screw) consisting of: Horizontal inlet spigot with self sealing gasket (1). Balancing damper with adjustment from the room side (2). Plenum box (3) from zinc plated sheet steel. Special formed perforated plate flow equalizer (4).

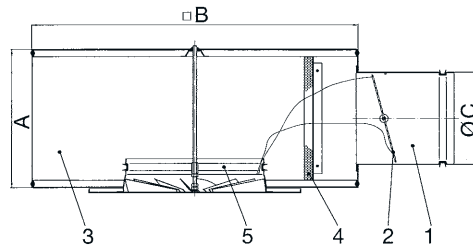
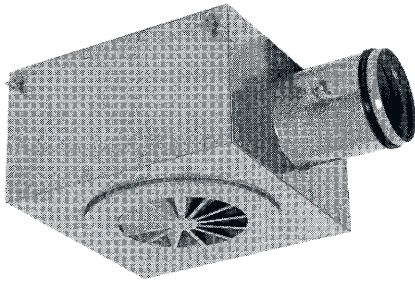

| Nominal diffuser size | Dimension in mm |     |     | Weight kg |
|-----------------------|-----------------|-----|-----|-----------|
|                       | A               | B   | C   |           |
| DN 125                | 155             | 300 | 98  | 3,13      |
| DN 160                | 200             | 400 | 123 | 6,71      |
| DN 200                | 200             | 400 | 158 | 7,17      |
| DN 250                | 290             | 585 | 198 | 12,7      |
| DN 315                | 290             | 585 | 248 | 13,5      |
| DN 355                | 300             | 650 | 248 | 15,7      |
| DN 400                | 500             | 650 | 313 | 19,0      |
| DN 450                | 500             | 650 | 353 | 19,5      |

Plenum boxes to special design are available on request.

#### Plenum box (Type AKH)

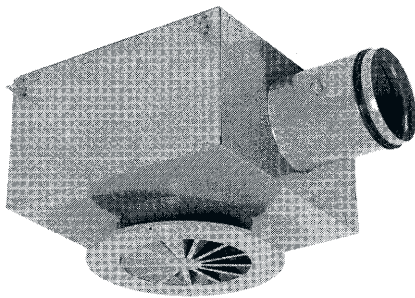

Plenum box mounted above suspended ceiling. The discharge collar length is 50 mm. The distance between the swirl diffuser face and the underside of the plenum is adjustable as shown.

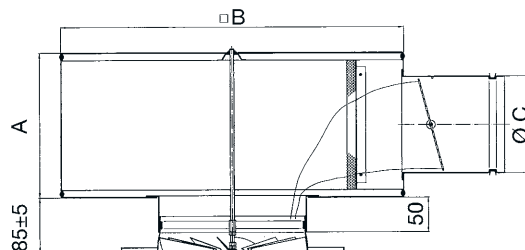

## Swirl diffuser Type DA

## Supplementary components Installation methods

### Supplementary components

To meet the necessary technical requirements, the following supplementary components are available.

#### Vane blanking (Type FA)

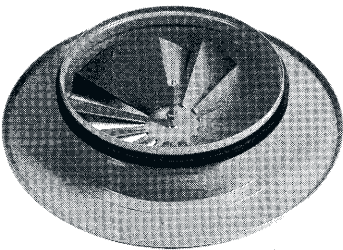

By means of vane blankings from Recticel, the air flow pattern in horizontal direction can be changed, e. g. to reduce the minimum distance between 2 diffusers or diffuser and wall.

#### Perforated plate mounted to the top of the diffuser (Type L)

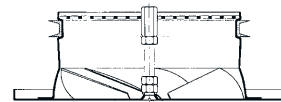

Swirl diffuser with perforated plate for direct connection to the duct.

### Installation methods

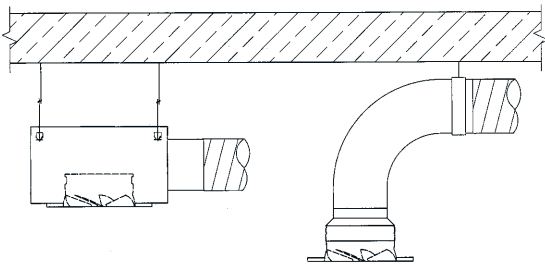

Visible installation without ceiling

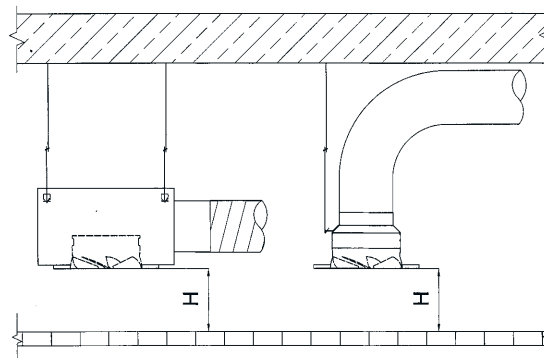

Installation above an open cell ceiling

The DA diffusers can be installed above an open cell ceiling but attention must be given to the distance above the open cell ceiling. The distance H must be at least equal to the dimension of the nominal size of the diffuser.

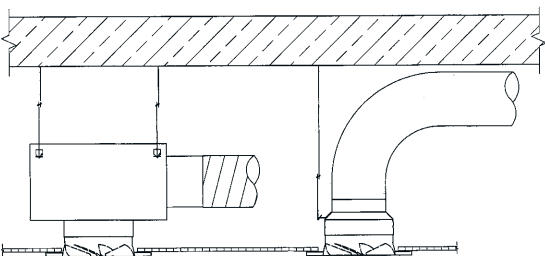

Installation in closed ceiling

## Swirl diffuser Type DA

## Design and selection data

### Selection data

In order to achieve the required comfort conditions in the occupied zone, it is necessary to take the following into account when selecting a diffuser:

- Correct diffuser size
- Temperature difference
- Total air flow rate
- Correct positioning of the diffusers, particularly the minimum distance between the diffusers

### Selection of the correct diffuser size

The diffuser size selection is initially based on the maximum and minimum flow rates to be handled by the individual diffuser.

### Minimum air flow rates at the diffuser

This value is the lowest limit where an horizontal air pattern can be maintained with stable conditions at a temperature difference between the supply and room air of 8 K cooling.

### Maximum air flow rate at the diffuser

The maximum air flow rate depends on:

- the maximum acceptable noise level
- the maximum acceptable air velocity in the occupied zone for comfort conditions

The maximum air flow rate as a function of the noise level and pressure loss are given in the graphs on page 11.

The maximum flow rate of each diffuser size relative to the allowable air velocity in the occupied zone is dependent on the mounting height of the diffuser. The selection data as shown in **Fig. 2**, results from tests where, within the occupied zone (defined as 1,8 m above the floor level) and at a room air temperature of 22° C, 84% of the velocity readings were less than 0,22 m/s measured with an instrument having a time constant of 0,1 s. These values are well within the requirements of DIN 1946 pt 2 which allows a time constant of up to 2 s.

**Fig. 1** shows the maximum and minimum flow rates for each size of diffuser. The maximum flow rate is based on a noise level of 35 NR when fitted with a connection cone type U.

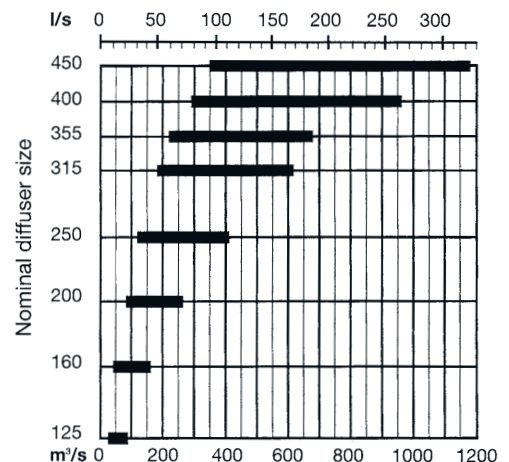

**Fig. 1. Max.-Min. flow rate range for each DA diffuser size. (Max flow rate is based on 35 NR)**



# Swirl diffuser Type DA

# Design and selection data

Fig. 2 gives the maximum flow rate for each diffuser size based on the room height to achieve comfort conditions in the occupied zone.

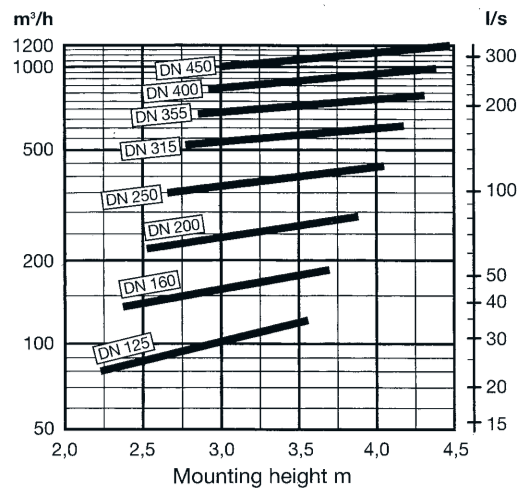

Fig. 2. Maximum flow rate for each size of diffuser relative to the mounting height for comfort conditions in the occupied zone.

## Minimum air flow rate for isothermal or heating conditions

In the case of isothermal or low heating ( $\Delta t \leq 6\text{K}$ ) applications it is necessary to achieve good air movement down to the floor, therefore when establishing the minimum mounting height, the flow rate should be at least 70% of the maximum flow rate value in Fig. 2.

## Selection of acceptable distances between diffusers

Fig. 3 provides the acceptable minimum distance allowable between diffusers as a function of the air flow rate and the mounting height in order to maintain comfort conditions in the occupied zone.

If the diffusers are positioned too close to each other there is the possibility that the swirling air streams can meet, therefore causing a vertical drop into the occupied zone resulting in excessively high velocities and draughty conditions. If the diffusers are positioned too far apart there is the risk that insufficient mixing will take place even at the required air change rate.

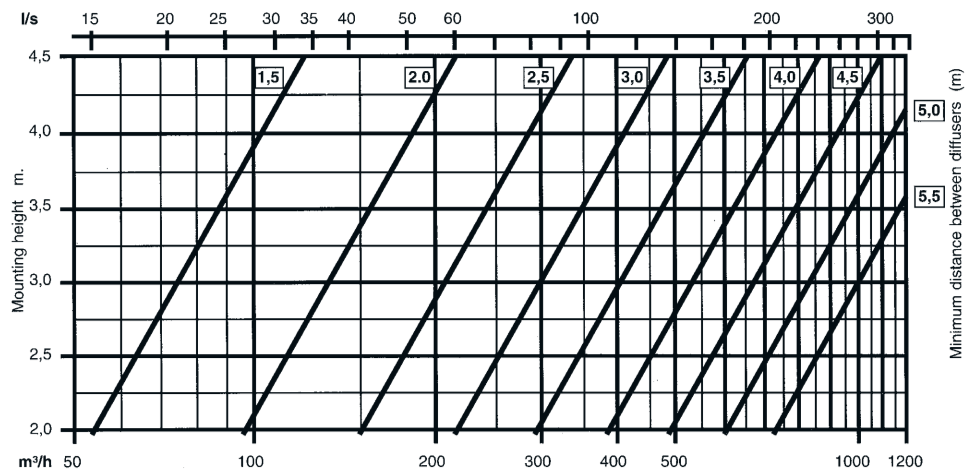

Fig. 3. Minimum distance between DA diffusers against air flow rate.

## Swirl diffuser Type DA

## Design and selection data

The minimum distance between diffusers can also be established by the following formulae.

$$t_{\min} = \sqrt{(q/12 \cdot H)} \quad (q \text{ in m}^3/\text{h})$$

or

$$t_{\min} = \sqrt{(q \cdot 0,3/H)} \quad (q \text{ in l/s})$$

where

$t_{\min}$  = min. distance between diffusers

$q$  = air flow rate

$H$  = mounting height of diffuser

### Air velocity in occupied zone relative to the distance between diffusers

If the distance between the diffusers is too small then the air velocity in the occupied zone increases, by increases the distance then the air velocity decreases.

Fig. 4 shows the relationship between the air velocity and the actual distance between the diffusers. The air velocity is shown as a function of the correction factor  $F$  where  $F$  is the quotient of the actual distance and the calculated minimum distance between the diffusers.

$$F = t_{\text{act}}/t_{\min}$$

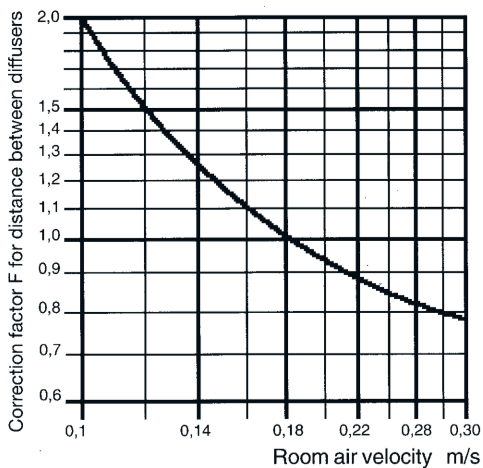

Fig. 4. Correction factor for distance between diffusers and room air velocity

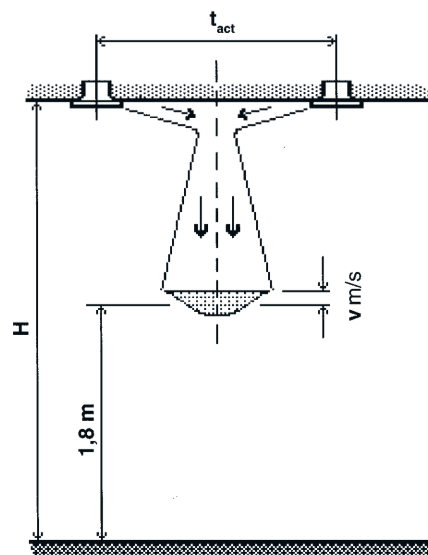

Fig. 5. Average air velocity in the occupied zone between diffusers.

# Swirl diffuser Type DA

# Pressure loss and noise levels

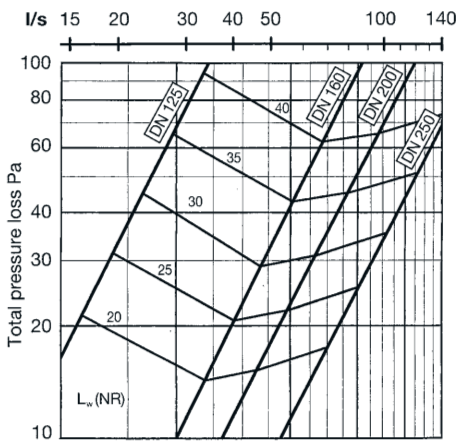

Fig. 6.1. Sizes 125 to 250 straight duct connection

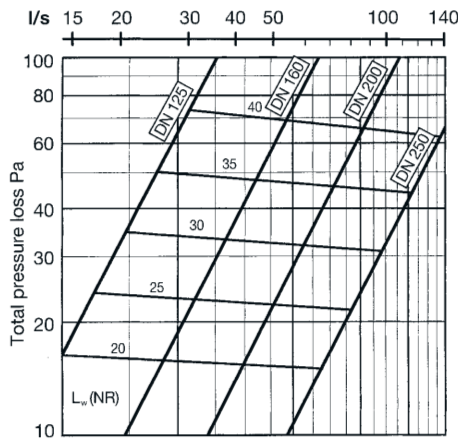

Fig. 6.2. Sizes 125 to 250 with cone connection Type U

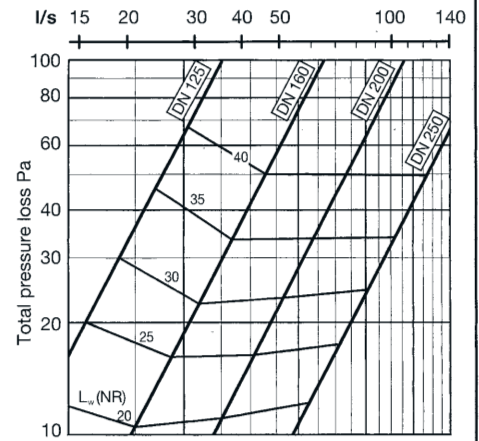

Fig. 6.3. Sizes 125 to 250 - With plenum box connection Types AK, AKL and AKH

Fig. 6. Pressure loss and noise levels against flow rates for DA diffuser range.

Note: The NR values have **NO ALLOWANCE** for room attenuation, deductions can be made of about 6 dB depending of the room characteristics.

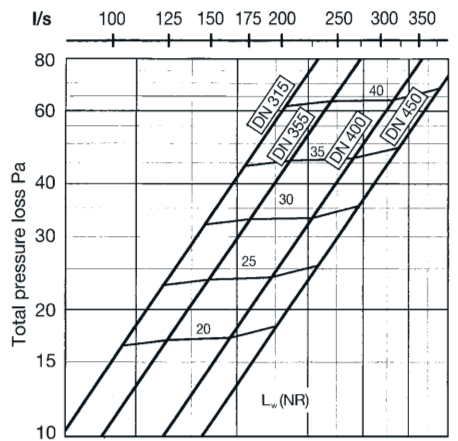

Fig. 6.4. Sizes 315 to 450 with cone connection Type U

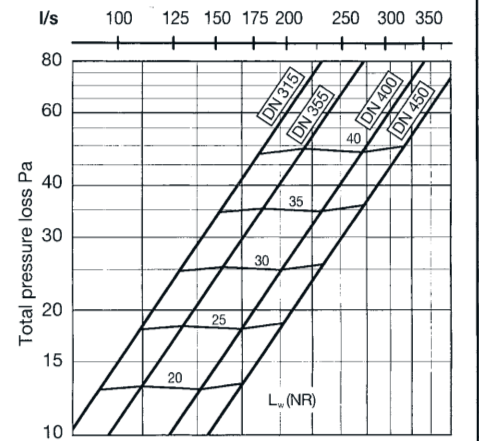

Fig. 6.5. Sizes 315 to 450 - with plenum box connection Types AK, AKL and AKH

### Conversion factors

The conversion factors F given in the table opposite can be used to establish sound power levels at mid-octave bands from 125 to 4000 Hz.

|                         | Hz        | 12  | 250 | 500 | 1000 | 2000 | 4000 |
|-------------------------|-----------|-----|-----|-----|------|------|------|
| DA only                 | Factor F  | -23 | -13 | -7  | -5   | -7   | -10  |
|                         | Deviation | ±5  | ±4  | ±2  | ±1   | ±3   | ±3   |
| DA with cone connection | Factor F  | -25 | -14 | -7  | -5   | -8   | -10  |
|                         | Deviation | ±5  | ±2  | ±2  | ±1   | ±2   | ±3   |
| DA with plenum box      | Factor F  | -14 | -11 | -7  | -5   | -7   | -10  |
|                         | Deviation | ±4  | ±4  | ±2  | ±2   | ±2   | ±2   |

## Swirl diffuser Type DA

## Selection example

### Selection example

#### Given:

An office with dimensions of:  
 Length: 12,5 m  
 Width: 9 m  
 Floor to ceiling: 3 m  
 Air flow rate:  $q$  650 l/s (2340 m<sup>3</sup>/h)  
 Temp. diff.: Cooling = 8 K  
 Heating = 2 K  
 Maximum noise level: 33 NR  
 Preferred diffuser size: DA 200  
 Required connection: Plenum box

#### Required:

Number of diffusers  
 Air flow rate/diffuser  
 Noise level  
 Air velocity in the occupied zone

#### Air flow rate per diffuser

From Fig. 6.3 the flow rate for a size 200 DA diffuser at 33 NR is 55 l/s (198 m<sup>3</sup>/h).

#### To find number of diffuser:

Theoretical number = Total air flow rate/Max. flow rate per diffuser  
 $= 650/55$   
 $= 11.8$  say **12 diffusers**,

therefore the actual flow rate per diffuser =  $650/12 = 54$  l/s (195 m<sup>3</sup>/h)

#### Position of diffusers

By setting out the diffusers as Fig. 7 it can be seen that the diffusers will be 3 m apart.

Minimum distance between diffusers =  $t_{\min} = \sqrt{(q \cdot 0,3/H)}$

$$t_{\min} = \sqrt{(54 \cdot 0,3/3)}$$

= **2,32 m** which satisfies the nominated 3 m

Lay-out with 3 m centres between diffusers.

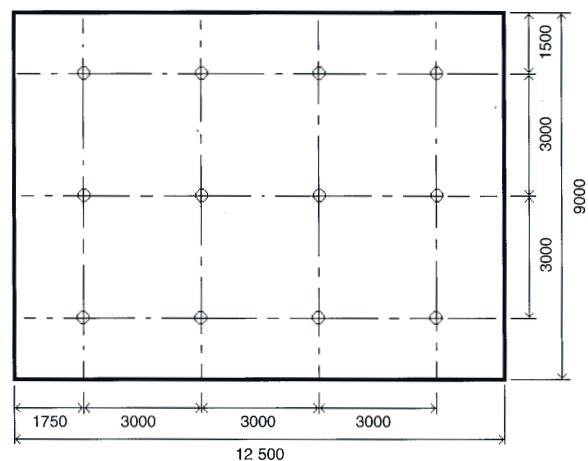

Fig. 7. Lay-out of diffusers of selection example

#### Results

Number of diffusers:  
 12 DA diffusers size 200 with plenum box type AKH

#### Pressure loss

Fig. 6.3 gives a pressure loss of 28 Pa for a size 200 DA diffuser with an AKH plenum box.

#### Noise level

Fig. 6.3 gives a noise level of 32 NR at the diffuser.

#### Air velocity in occupied zone

For the minimum distance between diffusers of 2,32 m and the actual distance of 3 m the correction factor F can be calculated:

$$F = 3,0/2,32 = 1,29$$

From Fig. 4 an air velocity of  $\leq 0,14$  m/s in the occupied zone can be derived.

# Tender text

| Position | Description   | No. of units | Unit price | Extended price |
|----------|---|--------------|------------|----------------|
|          | <p>Supply air swirl diffusers for applications requiring even air diffusion and the minimum possible temperature gradient.</p> <p>Air is introduced in the form of horizontally projecting swirling air streams.</p> <p>The diffuser consists of a steel plate having pressed swirl blade elements and an integral inlet spigot with self sealing gasket.</p> <p>Plenum box from zinc plated steel without inside insulation with adjustable damper.</p> <p><b>Swirl diffuser:</b></p> <p><b>Nom. diameter:</b>                      DN.....</p> <p><b>Material:</b></p> <p><input type="checkbox"/> Steel (standard)</p> <p><input type="checkbox"/> Stainless steel (1.4301)</p> <p><b>Face flange form:</b></p> <p><input type="checkbox"/> Circular (standard dimensions)      <b>(DA)</b></p> <p><input type="checkbox"/> Rectangular (standard dimensions) <b>(DA)</b></p> <p><input type="checkbox"/> Rectangular ..... <b>(DASF)</b></p> <p><input type="checkbox"/> Special design .....</p> <p><b>Finish (outer surface):</b></p> <p><input type="checkbox"/> Powder coated RAL 9010 (standard)</p> <p><input type="checkbox"/> Enamelled RAL ..... <b>(DA-RAL)</b></p> <p><input type="checkbox"/> .....</p> <p><b>Connection components:</b></p> <p><input type="checkbox"/> Connection cone                              <b>(U)</b></p> <p><input type="checkbox"/> Connection cone                              <b>(UF)</b></p> <p><input type="checkbox"/> Plenum box                                      <b>(DA-AK)</b></p> <p><input type="checkbox"/> Plenum box with collar                      <b>(DA-AKH)</b></p> <p><b>Supplementary components:</b></p> <p><input type="checkbox"/> Vane blanking                                 <b>(FA)</b></p> <p><input type="checkbox"/> Perforated plate                                <b>(L)</b></p> <p>Air flow rate:                                      ..... l/s or m<sup>3</sup>/h</p> <p>max. noise level:                                ..... NR or dB(A)</p> <p>max. pressure loss:                              ..... Pa</p> <p>Fabrikat:    STRULIK</p> <p>Typ:    <b>DA</b></p> |              |            |                |